



## Aldehyde-stabilized cryopreservation



Robert L. McIntyre\*, Gregory M. Fahy

21st Century Medicine, 14960 Hilton Drive, Fontana, CA 92336, USA

### ARTICLE INFO

#### Article history:

Received 24 June 2015

Received in revised form

31 August 2015

Accepted 1 September 2015

Available online 25 September 2015

#### Keywords:

Vitrification

Connectomics

Brain banking

Perfusion

Fixation

Electron microscopy

Cryopreservation

Neuroanatomy

Ultrastructure

Pig

Rabbit

Cryoprotective agents

Long term storage

### ABSTRACT

We describe here a new cryobiological and neurobiological technique, aldehyde-stabilized cryopreservation (ASC), which demonstrates the relevance and utility of advanced cryopreservation science for the neurobiological research community. ASC is a new brain-banking technique designed to facilitate neuroanatomic research such as connectomics research, and has the unique ability to combine stable long term ice-free sample storage with excellent anatomical resolution. To demonstrate the feasibility of ASC, we perfuse-fixed rabbit and pig brains with a glutaraldehyde-based fixative, then slowly perfused increasing concentrations of ethylene glycol over several hours in a manner similar to techniques used for whole organ cryopreservation. Once 65% w/v ethylene glycol was reached, we vitrified brains at  $-135\text{ }^{\circ}\text{C}$  for indefinite long-term storage. Vitrified brains were rewarmed and the cryoprotectant removed either by perfusion or gradual diffusion from brain slices. We evaluated ASC-processed brains by electron microscopy of multiple regions across the whole brain and by Focused Ion Beam Milling and Scanning Electron Microscopy (FIB-SEM) imaging of selected brain volumes. Preservation was uniformly excellent: processes were easily traceable and synapses were crisp in both species. Aldehyde-stabilized cryopreservation has many advantages over other brain-banking techniques: chemicals are delivered via perfusion, which enables easy scaling to brains of any size; vitrification ensures that the ultrastructure of the brain will not degrade even over very long storage times; and the cryoprotectant can be removed, yielding a perfusable aldehyde-preserved brain which is suitable for a wide variety of brain assays.

© 2015 The Authors. Published by Elsevier Inc. This is an open access article under the CC BY license (<http://creativecommons.org/licenses/by/4.0/>).

### 1. Introduction

The objective of the present studies was to demonstrate that cryobiological techniques can be used to enable brain banking to support the needs of fields such as the emerging domain of whole brain connectomics [7]. Connectomics is the study of the totality of all neuronal connections in individual brains so as to better understand the functions of the brain and the emergence of mind [33,34]. Connectomics involves tracing the linkages between nerve cells; currently available connectomics methods often trace these linkages in fixed brains.

In contrast to the requirements of many cryopreservation protocols, brain banking for connectomics research does not necessarily need to preserve the biological viability of brain tissue; the primary criterion for success is instead to maintain the delicate ultrastructural appearance of the brain.

Our goals in developing a robust, general-purpose brain banking protocol for connectomics research were that such a procedure must:

1. Provide the highest quality of ultrastructural preservation with minimal distortion.
2. Easily scale to brains of any size.
3. Enable indefinite storage of whole brains, with no ultrastructural changes during storage.
4. Remain compatible with as many neuroanatomical assays as possible.

Currently, there is no brain banking technique that achieves all four of our goals: while there are many techniques that are used in practice to preserve brain tissue, they all fail to meet one or more of our four requirements.

The mainstay method for whole brain preservation involves perfusing the brain [28] with aldehydes [18,19] and storing the fixed brain at a relatively warm temperature,  $4\text{ }^{\circ}\text{C}$ . While this technique has been used for decades, it does not guarantee static preservation of brain ultrastructure over the course of years,

\* Corresponding author.

E-mail addresses: [rlm@21cm.com](mailto:rlm@21cm.com), [rlm@mit.edu](mailto:rlm@mit.edu) (R.L. McIntyre), [gfhay@21cm.com](mailto:gfhay@21cm.com) (G.M. Fahy).

because the fixed brain is still chemically active at 4 °C and can undergo chemical and morphological degradation over long storage times [20,37]. Nor is it possible to simply store fixed brains at sub-zero temperatures to inhibit chemical degradation, because the resulting formation of ice will cause significant dehydration and mechanical damage to the ultrastructure of the brain [8]. In fact, fixed tissue often suffers even more severe damage during freezing than unfixed tissue, although this can be somewhat mitigated by immersing fixed brain tissue in cryoprotectants [30].

Another method for whole brain preservation is the recently developed technique of whole brain staining and resin embedding [25,26]. This approach shows great promise for stabilizing brains in resin at room temperature indefinitely. However, current staining and embedding techniques are based on diffusion of highly viscous embedding materials inward from the brain surface over macroscopic distances through fairly dense fixed brain tissue. The time required to diffuse chemicals into a brain theoretically scales quadratically with brain mass, making whole brain staining and resin embedding impractical for larger brains (>10 g). Even a hypothetical staining and resin embedding procedure which employed perfusion to avoid the quadratic slowdown would have to pre-commit to a particular sort of stain and resin, limiting its use as a general-purpose brain-banking protocol, because both staining and resin embedding are irreversible, and resin-embedded brains cannot be reperfused with other chemicals. For example, resin-embedded brains would not be compatible with techniques such as expansion microscopy [3] or the CLARITY protocol [4], which require perfusion of a hydrogel after aldehyde fixation.

A third method for brain preservation, vitrification, involves perfusing organs with very high concentrations of cryoprotective agents (CPAs) and then storing them at extremely low temperatures such as −135 °C [8]. The CPAs prevent ice formation during cooling and instead the entire system becomes a solid glass [36]. Vitrification has the potential to preserve biological systems indefinitely with no ice-mediated damage while maintaining biological viability [16], but cryoprotective additives (CPAs) can themselves be toxic [5,14] and cause osmotic dehydration if added too quickly.

Successful vitrification protocols must therefore make a compromise between minimizing exposure to toxic CPAs (by minimizing CPA equilibration times) and minimizing exposure to dehydration and osmotic stress (by maximizing CPA equilibration times) [17]. For cryoprotecting the brain, the problem of dehydration is particularly severe because of the blood–brain barrier (BBB), which limits the rate at which cryoprotectants can enter the brain, thus causing major osmotic brain shrinkage [10]. For the purposes of connectomics, this dehydration is undesirable because it distorts the brain's ultrastructure and causes difficulties in tracing fine neural processes.

To address the limitations of the previous methods discussed, we conceived of a simple solution that meets our four brain banking goals: aldehyde-stabilized cryopreservation (ASC). We fixed brains using aldehyde perfusion, then gradually perfused those brains with sufficiently high concentrations of cryoprotectant to enable vitrification. The aldehydes immediately stabilize the fine structure of the brain to an extent sufficient for connectomics research, meeting our goal of high-quality preservation. Once the brain is fixed, cryoprotectant toxicity and other chemical insults are of minimal concern. Therefore we were able to add cryoprotectant more gradually and to include a surfactant to accelerate CPA introduction by breaking down the BBB, allowing us to achieve dehydration-free vitrification.

Biological time in vitrified systems is essentially arrested [8,9], enabling very long term storage. In principle, ASC is scalable to brains of any size because all chemicals can be delivered by

perfusion, and the distance between capillaries is essentially independent of the size of perfused organs. Finally, cryoprotectants can be removed from the brain after warming to yield an aldehyde preserved brain, a common currency among connectomics assays: traditional resin embedding [19], the BROPA whole brain embedding protocol [26], CLARITY [4], the BrainBow method [24], expansion microscopy [3], and immunocytochemical assays [18] might all be compatible with aldehyde-stabilized cryopreserved brains.

In this paper, we describe our initial exploration of achieving good brain cryopreservation by the ASC method. We describe here the applicability of this method to both small (rabbit, 10 g) and large (pig, 80 g) brains. The results show exquisite preservation of anatomical detail in both models after vitrification and rewarming, with virtually no identifiable artifacts relative to controls.

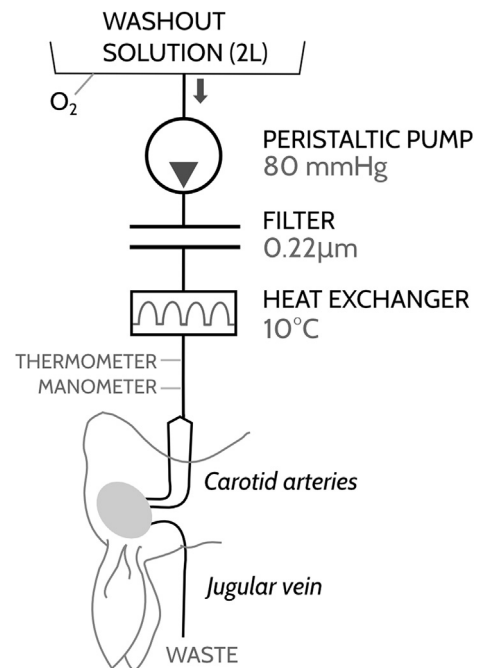
## 2. Materials and methods

### 2.1. Animals

We used 37 adult (12–36 week old) male New Zealand White (NZW) rabbits (obtained from Charles River Laboratories) and 3 young (3–4 month old) female Yorkshire pigs (obtained from SNS Farms). The rabbits were used to refine the parameters of the ASC protocol as determined by electron microscopy of brain tissue, and the pigs were used to demonstrate preservation of larger brains using ASC. All procedures were approved by 21st Century Medicine's Institutional Animal Care and Use Committee and were in full compliance with USDA standards and guidelines for animal care.

### 2.2. Perfusion machine

Our rabbit cephalon perfusion machine consisted of two parts: 1) A mobile cart (washout cart) described in Fig. 1, which was



**Fig. 1.** The washout cart was used to wash out the rabbit's blood, then to move the cephalon to the CPA circuit (Fig. 2) for fixation and cryoprotectant introduction. The washout circuit consisted of a 2 L reservoir of oxygenated blood washout solution, a 0.22 µm filter, heat exchanger (ice water and heat exchanger pump not pictured), and a thermometer and manometer to monitor perfusion parameters.

present during the initial surgery and which we used to wash out blood and cool the rabbit brain, and 2) a computer-controlled perfusion apparatus (CPA circuit), which was entirely contained in a fume hood (Fig. 2), which we used for fixation and the cryoprotectant concentration ramp.

The washout cart (Fig. 1) consisted of a 2 L reservoir of washout solution connected in series with a “T” junction, a peristaltic pump, a Millipore 0.22  $\mu\text{m}$  filter, a glass heat exchanger, and a Y-connector, which terminated in a pair of cannulae spaced to match the separation distance between the carotid arteries of a typical rabbit. There was a manometer attached via a side arm directly before the cannulae, which we used to control the pressure during perfusion. There was also a Physitemp MT-23 thermocouple needle probe inserted into the tubing immediately before the carotid cannulae, which we used to monitor perfusate temperature. The cart contained an uninterruptible power supply to enable continuous perfusion of the rabbit cephalon during transport between the operating room and the perfusion room.

The CPA circuit (Fig. 2) consisted of a linear gradient generator, two computer-controlled peristaltic pumps (one for perfusion and one to create the cryoprotectant gradient), and a digital manometer. For additional details on the principles of using a recirculating gradient generator to perfuse organs with cryoprotectants, see Refs. [11,13].

### 2.3. Chemicals

We used only pharmaceutical grade or higher chemicals in our washout solutions. A full list of chemicals and suppliers is provided in Table 1.

### 2.4. Blood washout solutions

Blood washout solutions (Table 2, Table 3) were adjusted to pH 7.40 with HCl and filtered using a Millipore 0.22  $\mu\text{m}$  filter. We oxygenated blood washout solutions by bubbling  $\text{O}_2$  for at least 1 h before use. The washout solutions were oxygenated at room

temperature and cooled using the heat exchanger described in Fig. 1.

For some experiments, we used a modified Krebs–Ringer's solution (KR8H) (Table 3) as a blood washout solution instead of the PBS washout solution.

We also occasionally included 10 g/L sodium nitrite in the PBS washout solution as a vasodilator [28].

### 2.5. Fixative solution

The fixative solution was a standard 3% w/v glutaraldehyde solution in a 0.1 M phosphate buffer (Table 4) [19,21].

The fixative solution was adjusted to pH 7.40 with HCl and filtered with a Millipore 0.22  $\mu\text{m}$  filter. The osmolarity of the phosphate buffer was 238 mOsm, and the osmolality of the entire fixative solution was 620 mOsm, as measured by a Precision Systems “Osmette A” freezing point depression osmometer.

We found in these studies that “biological grade” glutaraldehyde was just as effective in giving good ultrastructural preservation as the more expensive “electron microscopy grade” glutaraldehyde [29], and we therefore used “biological grade” glutaraldehyde for the vast majority of our studies.

### 2.6. Fixative additives

We also used small quantities of sodium dodecyl sulfate (SDS) to prevent brain shrinkage and sodium azide to prevent mitochondrial swelling (Table 5).

### 2.7. Cryoprotectant solution

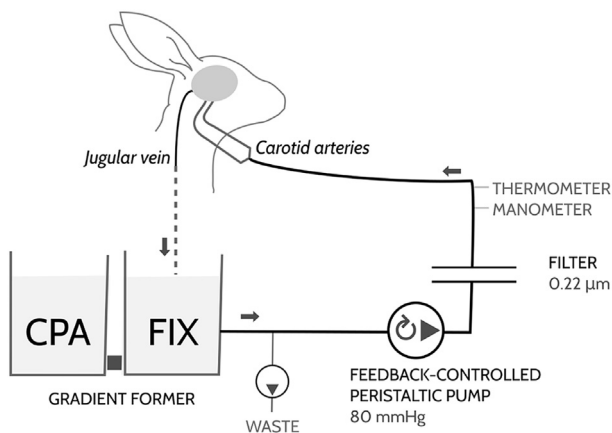
Our cryoprotectant solution (Table 6) was the same as the fixative solution, except it also contained 65% w/v ethylene glycol. We filtered this solution with a Millipore 0.22  $\mu\text{m}$  filter, but did not adjust the pH.

### 2.8. Surgery – bilateral carotid cannulation

Anesthesia was induced in rabbits with an injection of 50 mg/kg ketamine and 5 mg/kg xylazine. Rabbits were kept at an appropriate surgical plane of anesthesia using 1%–5% isoflurane with 100%  $\text{O}_2$  by mask.

Bilateral carotid cannulation was performed under anesthesia as follows: An incision was made in the neck, and the carotids were exposed and dissected free of surrounding tissue. Ligatures were looped loosely around both common carotid arteries. Trickle flow through one carotid cannula was then begun while the contralateral carotid line remained clamped. A nick was made in one common carotid, and the low-flow cannula was immediately inserted and full perfusion with oxygenated washout solution immediately instituted at 80 mmHg. Within 30 s the ipsilateral jugular vein was severed and the carotid was firmly ligated onto the perfusing cannula. Then the clamp on the contralateral carotid cannula was released, the second carotid was cannulated, and the contralateral jugular vein was cut. Cannulation of both carotids took approximately 2 min and did not result in any cerebral ischemia since the Circle of Willis remained perfused through at least three pathways at all times (two vertebral arteries and at least one carotid artery).

Washout continued for 5 min–10 min at 10 °C after the completion of cannulation. The rabbit cephalon was then surgically separated from the body and rolled on the washout cart (Fig. 1) to the CPA circuit (Fig. 2) in the fume hood while perfusion continued.



**Fig. 2.** The CPA circuit was entirely contained in a fume hood, and was used to fix the rabbit brain and to introduce CPA. It consisted of a gradient generator, a computer-controlled peristaltic pump, a waste pump, a 0.22  $\mu\text{m}$  filter, and a digital manometer and thermometer. The gradient generator consisted of adjacent reservoirs of cryoprotectant solution (CPA) and fixative solution (FIX) connected by a short tube. The fixative reservoir was continuously stirred by a magnetic stir bar. A waste pump was used to lower the level of the gradient generator and create the gradient. The computer adjusted the flow rate of the feedback-controlled perfusion pump to maintain constant pressure of the cephalon. To mimic standard neurobiology procedures, fixation was done at approximately room temperature. We used a series of switches to transition the cephalon to this circuit without interrupting flow (see Fig. 3).

**Table 1**

Chemicals used for anesthesia, blood washout solutions, fixatives, and to process samples for electron microscopy.

Chemical	Supplier	City	Catalog/ID no.
Xylazine	Lloyd	Shenandoah, Iowa	139-236
Isoflurane	Clipper	St Joseph, Missouri	57319-559-06
Ketamine	Putney	Portland, Maine	26637-411-01
Euthasol	Virbac	Fort Worth, Texas	051311-050-01
Sodium Heparin	Hospira	Lake Forest, Illinois	0409-2720-03
Chlorpromazine HCl	West Ward	Eatontown, New Jersey	0641-1397-35
PBS 10× Concentrate	Fisher	Pittsburgh, Pennsylvania	BP665
NaH <sub>2</sub> PO <sub>4</sub> ·2H <sub>2</sub> O	Sigma	St. Louis, Missouri	04269
Na <sub>2</sub> HPO <sub>4</sub> ·2H <sub>2</sub> O	Sigma	—	30435
Glucose	Fisher	—	D16-10
NaCl	Fisher	—	S671-3
Sodium HEPES	Sigma	—	H7006
NaHCO <sub>3</sub>	Fisher	—	S233-3
K <sub>2</sub> HPO <sub>4</sub> ·3H <sub>2</sub> O	Sigma	—	P5504
CaCl <sub>2</sub> ·2H <sub>2</sub> O	Sigma	—	C7902
MgCl <sub>2</sub> ·6H <sub>2</sub> O	Fisher	—	M35-212
Hydroxyethyl Starch	Serumwerk	Bernburg, Germany	450/0.7
Glutaraldehyde	Fisher	—	G-151-1
Sodium Azide	Sigma	—	S2002
Sodium Nitrite	Sigma	—	S2552
Sodium Dodecyl Sulfate	Sigma	—	L3771
Ethylene Glycol	Spectrum	Gardena, CA	E1051
Agar	Sigma	—	05039
Sodium Cacodylate, 0.2 M	EMS <sup>a</sup>	Hatfield, Pennsylvania	11652
K <sub>4</sub> Fe(CN) <sub>6</sub> ·3H <sub>2</sub> O	Sigma	—	P3289
OsO <sub>4</sub> (4% Solution)	EMS	—	19150
Uranyl Acetate Dihydrate	EMS	—	22400
Absolute Ethanol	EMS	—	15055
Propylene Oxide	EMS	—	20401
SPURS Embedding Kit	EMS	—	14300

<sup>a</sup> Electron Microscopy Sciences.

### 2.9. Initial fixation

After moving the cephalon to the fume hood as described above, we attached a reservoir containing 2 L of fixative solution (Table 4) with SDS and sodium azide additives (Table 5) to the washout circuit via the “T” junction. We perfused this initial fixative at room temperature and 80 mmHg in an open circuit until the level of the fixative reservoir reached 200 mL, which took 10 min–20 min depending on the flow rate of the cephalon.

### 2.10. Transfer to computer control

While perfusing the initial fixative solution, we replaced the manometer with a digital manometer and prepared the perfusion system as detailed in Fig. 3. Once the initial fixative reservoir reached 200 mL, we gradually decreased the speed of the cart's peristaltic pump, and the computer-controlled pump (Cole Parmer 07550-30 under National Instruments LabView version 10.0.1 software control) gradually increased to keep the perfusion pressure at 80 mmHg. At no point during this transfer did the brain experience any interruption of flow. Once transfer to computer control was complete, we moved the cephalon to the gradient generator and began recirculating fixative without additives (Table 4, Fig. 2). The gradient generator contained 1.5 L of fixative solution and 1.5 L of CPA solution for a total of 3 L.

**Table 2**

Composition of the PBS (phosphate-buffered saline) blood washout solution.

Chemical	Concentration
PBS 10× Concentrate	100 mL/L
Ketamine	5.40 mL/L
Sodium Heparin	0.50 mL/L
Euthasol	0.35 mL/L

### 2.11. Cryoprotectant introduction

After 45 min total fixative perfusion time, we engaged the gradient generator and started a gradual linear increase in CPA concentration. The CPA ramp took 4 h total, during which the computer decreased the perfusion pump speed to maintain perfusion pressure at 80 mmHg as the viscosity of the solution increased. After exhausting the solutions in the gradient generator, we recirculated 500 mL of fresh CPA solution for 1 h to ensure complete equilibration of cryoprotectant. After this 1 h CPA plateau we discontinued perfusion and removed the cephalon from the perfusion machine.

### 2.12. Changes in cephalon temperature during surgery, fixation, and CPA introduction

Rabbit cephalons remained at body temperature (37 °C) during surgery. The perfusion temperature decreased over the course of around 5 min to 20 °C once we introduced the cooled washout

**Table 3**

Composition of KR8H: Krebs–Ringer's based blood washout solution.

Chemical	Concentration
Hydroxyethyl Starch	60.00 g/L
NaCl	7.59 g/L
Glucose	1.8 g/L
Sodium HEPES	1.30 g/L
MgCl <sub>2</sub> ·6H <sub>2</sub> O	1.017 g/L
CaCl <sub>2</sub> ·2H <sub>2</sub> O	0.169 g/L
K <sub>2</sub> HPO <sub>4</sub> ·3H <sub>2</sub> O	0.51 g/L
NaHCO <sub>3</sub>	0.42 g/L
Ketamine	5.40 mL/L
Sodium Heparin	0.50 mL/L
Chlorpromazine HCl	0.432 mL/L

**Table 4**  
Fixative formula.

Chemical	Concentration
Na <sub>2</sub> HPO <sub>4</sub> ·2H <sub>2</sub> O	14.65 g/L
NaH <sub>2</sub> PO <sub>4</sub> ·2H <sub>2</sub> O	2.76 g/L
Glutaraldehyde	3% w/v

solution. When fixation began, the cephalic temperature was typically around 12 °C. With the introduction of room-temperature fixative solution, the perfusion temperature rose to room-temperature (22 °C) within 2 min–3 min and remained at room-temperature throughout the cryoprotectant gradient and cryoprotectant plateau.

### 2.13. Vitrification

Cryoprotected rabbit cephalons were placed in a 21st Century Medicine, Inc. Controllable Isothermal Vapor Storage (CIVS) device, which maintained temperature at –140 °C. Rabbit cephalons were stored in the CIVS for at least 48 h and in some cases for several weeks. Temperature was monitored by a Physitemp MT-23 thermocouple needle probe inserted into the rabbits' pharynxes. It typically required 12 h for rabbit cephalons to reach –135 °C as measured by this thermocouple. We kept rabbit cephalons in the CIVS unit for at least 48 h before further processing.

### 2.14. Application of ASC to porcine brains

For pigs, we used a larger and simpler version of the rabbit perfusion machine, which did not contain a heat exchanger or initial fixative reservoir and which had manual instead of computer-controlled pumps.

As in the case of rabbit experiments, bilateral carotid cannulation was performed while avoiding interruption of perfusion to the brain during blood washout as described above. Blood washout was performed at room temperature instead of at 10 °C, again using an oxygen-saturated perfusate. All solutions (blood washout, fixative, and cryoprotectant) were as described previously.

The fixation and cryoprotection schedules for pig brains were the same as for rabbit brains: a 45-min fixation period followed by a 4 h linear CPA ramp followed by recirculation of the full-concentration CPA solution for 1 h. We maintained the perfusion pressure a bit higher than in the case of rabbits (80–100 mmHg) during the CPA ramp owing to the modestly higher vascular resistance of larger organs. We used 8 L total fixative in the gradient generator – 4 L fixative and 4 L CPA solution. We used 1 L CPA solution during the CPA plateau. Because the pig cephalon perfusion machine did not have a separate initial fixative reservoir, we included the sodium azide and SDS additives at full concentration in the entire 4 L fixative solution in the gradient generator.

Pig cephalons were stored at least one week in the CIVS unit. We found that pig cephalons reached –135 °C after 24 h in the CIVS, as measured by a needle thermocouple probe deeply inserted into the pig's pharynx via the snout.

**Table 5**

Fixative additives – these chemicals were present in the first 2 L of fixative which was perfused in an open circuit at the start of fixation.

Chemical	Concentration
Sodium Dodecyl Sulfate	0.01% w/v
Sodium Azide	0.1% w/v

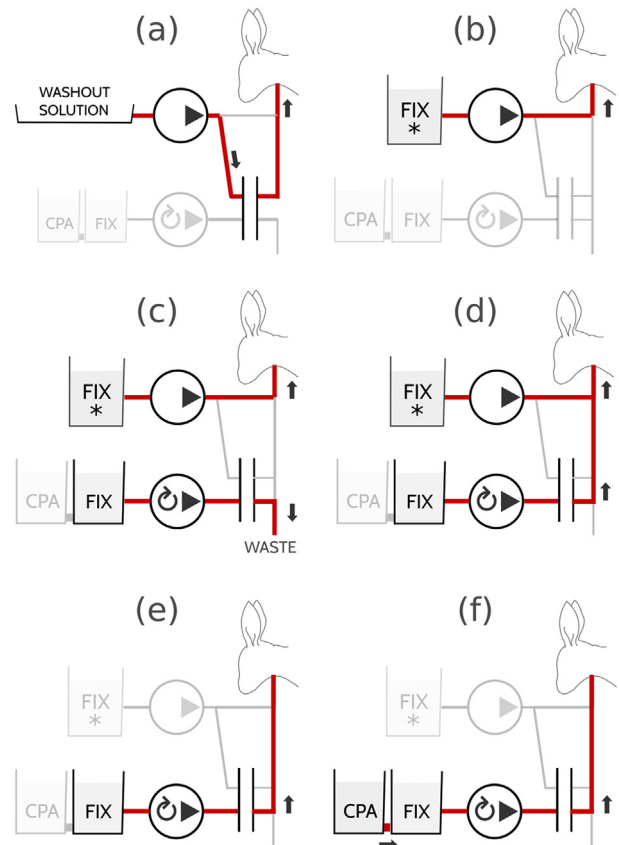
**Table 6**  
Cryoprotectant solution.

Chemical	Concentration
Na <sub>2</sub> HPO <sub>4</sub> ·2H <sub>2</sub> O	14.65 g/L
NaH <sub>2</sub> PO <sub>4</sub> ·2H <sub>2</sub> O	2.76 g/L
Glutaraldehyde	3% w/v
Ethylene Glycol	65% w/v

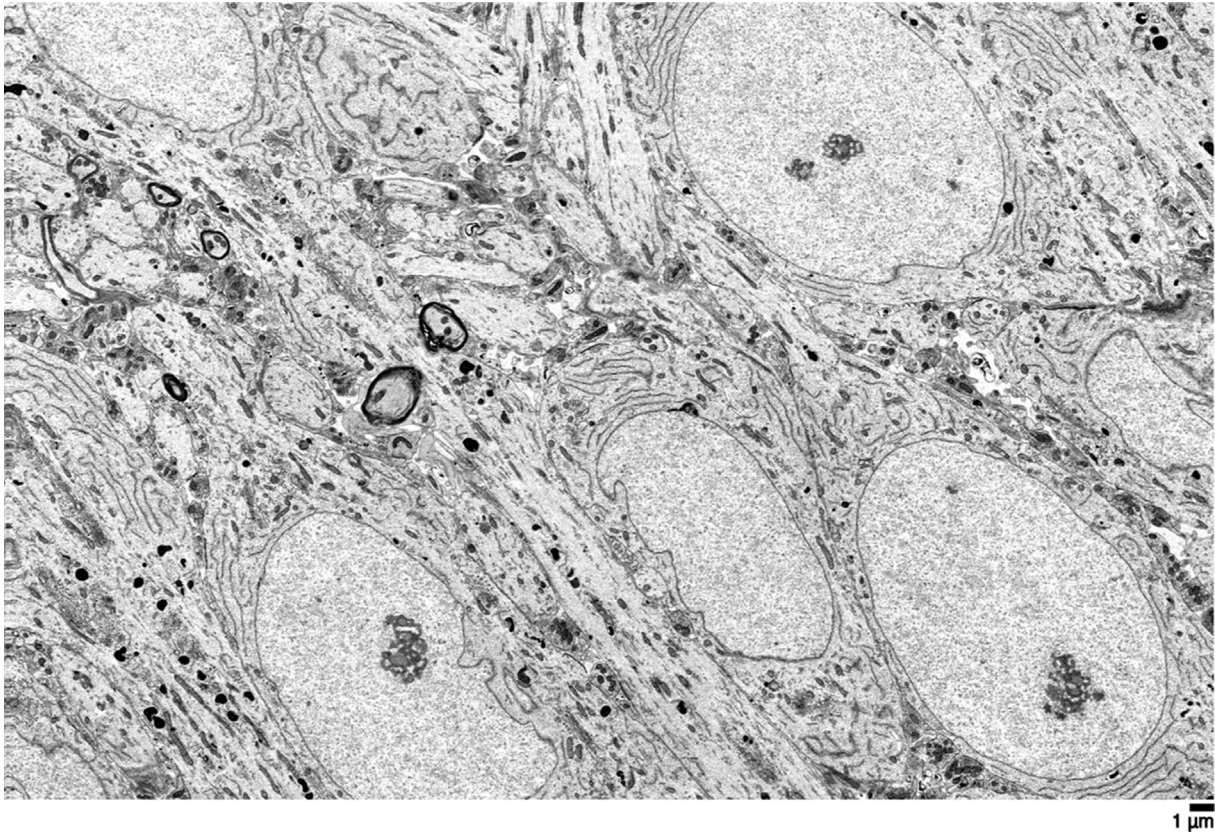
### 2.15. Warming and removal of CPA

After vitrification, we removed the cephalon (pig or rabbit) from the CIVS unit and allowed it to warm to room temperature in a fume hood for 2 h. We removed CPA from rabbit brains using either perfusion removal from rabbit cephalons or diffusion removal from rabbit brain slices. We removed CPA from pig brains using diffusion from brain slices only.

For perfusion removal of CPA from rabbit brains we used essentially the reverse of the process that was used to load CPA into the rabbit brain: We reattached the rabbit cephalon to the computer-controlled perfusion machine (Fig. 2) and removed CPA via a slow linear decrease over 4 h using the gradient generator. The computer increased the flow rate to keep the pressure constant at 80 mmHg as the viscosity of the perfusate decreased. After



**Fig. 3.** Initial fixation was accomplished by replacing the container of washout solution (a) with a container of 2 L of fixative with additives (FIX\*) and bypassing the filter (b) to avoid fixative dilution by fluid in the filter. While this initial fixative perfusion was underway, we cleared the filter of blood washout solution by perfusing it with fixative in parallel using the computer-controlled pump (c). Transfer to computer control was accomplished by joining the two pathways (d) and gradually decreasing the speed of the manual pump, causing the computer to increase the rate of the computer-controlled pump to compensate, without disrupting flow to the cephalon (e). After 45 min of total fixation time, we started the CPA ramp (f).



**Fig. 4.** Cells of the CA1 band of rabbit hippocampus. Control: Brains were washed out with PBS washout solution, fixed for 45 min, then stained and embedded. Experiment date: 2015-05-27. 2,420 $\times$ .

exhausting the solutions in the gradient generator (1.5 L of fixative solution and 1.5 L of CPA solution for a total of 3 L), we recirculated 500 mL fresh fixative solution for 1 h to ensure complete removal of cryoprotectant.

After removing CPA via perfusion, we disconnected the cephalon from the perfusion machine, extracted the brain from the skull, embedded it in agar, and cut 150  $\mu$ m coronal slices on a Pelco 100 vibratome. We placed the slices in small vials filled with 0.1 M cacodylate buffer (pH 7.4, 200 mOsm).

For diffusion removal of cryoprotectant, we extracted the CPA loaded brain from the skull, embedded it in agar containing 65% w/v ethylene glycol, and cut 150  $\mu$ m coronal slices on the vibratome, which we placed in small vials filled with CPA solution. We removed the CPA from the brain slices via exponential dilution with 0.1 M cacodylate, replacing half of the CPA solution surrounding the slices with 0.1 M cacodylate once every 10 min. We considered the CPA to be removed after completing five rounds of exponential dilution (to a final concentration of approximately 3% w/v ethylene glycol).

For porcine brains, we cut the brain into 3.2 cm  $\times$  1.2 cm  $\times$  2 cm blocks using a Thomas Scientific tissue slicer blade (catalog #6727C18), embedded those blocks in agar containing 65% w/v ethylene glycol, and cut vibratome slices and removed CPA as described for rabbit brain slices.

#### 2.16. Staining and embedding brain tissue for electron microscopy

After removing the CPA, we used the Focused Ion Beam Milling and Scanning Electron Microscopy (FIB-SEM) protocol for staining and dehydration as described by Graham Knott et al. [22]. We washed the brain slices three times with 0.1 M cacodylate for

5 min each, then stained with 1.5% w/v potassium ferrocyanide and 1% w/v osmium tetroxide in 0.1 M cacodylate buffer for 30 min. Next, we stained slices with 1.0% w/v osmium tetroxide in 0.1 M cacodylate buffer for 30 min. We washed the brain slices with double distilled water for 3 min and then stained them with 1% w/v uranyl acetate solution for 30 min. Then we washed the brain slices with double distilled water for 5 min and dehydrated the slices in a graded ethanol series: 50% ethanol for 2 min, 70% ethanol for 2 min, and finally four successive rinses with 100% ethanol for 2 min each.

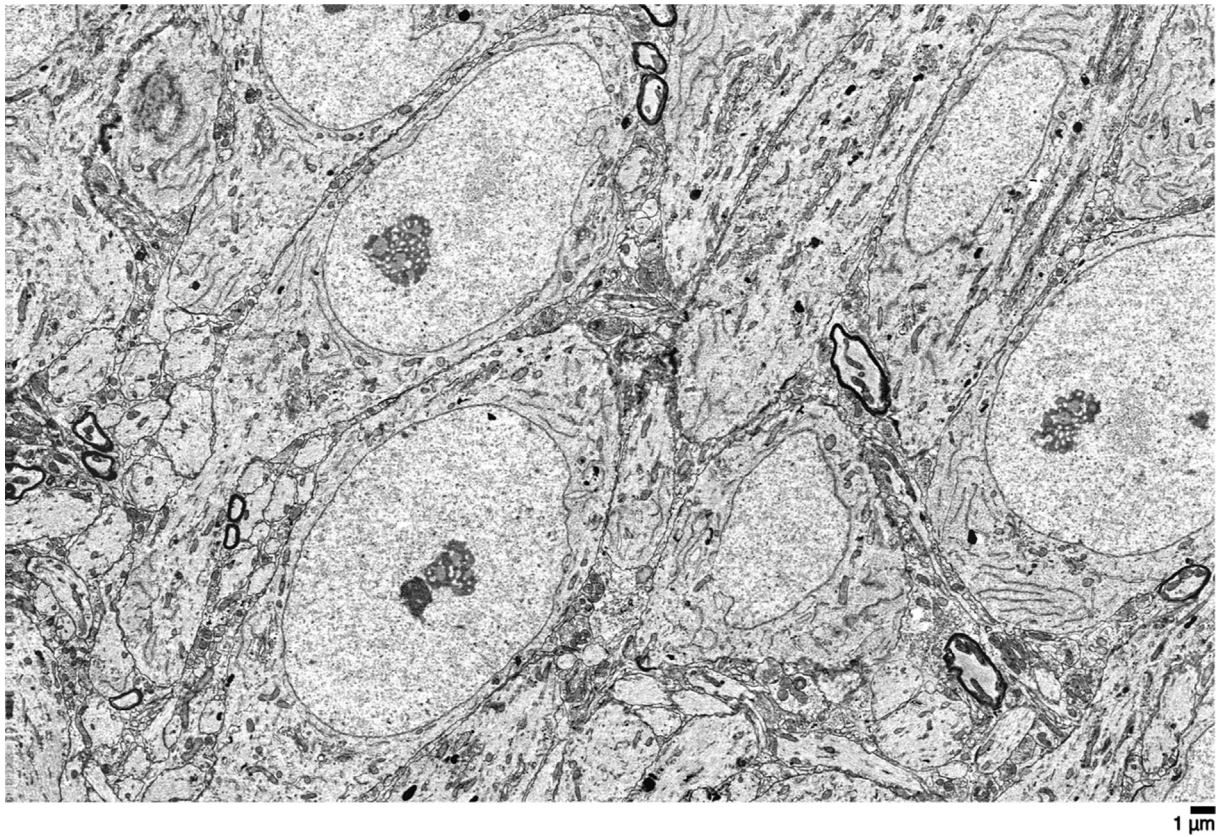
We embedded brain slices in SPURS resin using 3 rounds of 100% propylene oxide (PO) for 3 min each, followed by a 1:1 mixture of SPURS resin and PO for 30 min, then 1:2 PO:SPURS for 30 min, then finally 100% SPURS for 12 h overnight. We transferred the samples to fresh SPURS resin and polymerized the resin in a Quincy Lab Inc. Model GC laboratory oven at 65  $^{\circ}$ C for 48 h.

After hardening we cut 0.33  $\mu$ m thick sections for histology using a Reichert-Jung Ultracut-E ultramicrotome, stained those sections with toluidine blue, and viewed them under a Nikon eclipse 50i light microscope using Nikon Plan Achromat 4 $\times$ , 10 $\times$ , 20 $\times$ , and 40 $\times$  objective lenses.

For electron microscopy, we cut 80 nm thin sections on the ultramicrotome using a Diatome diamond knife, then coated the sections with a 10 nm layer of carbon in a Bal-Tec SCD 500 carbon coater. We viewed sections on a Zeiss Supra 40VP FESEM using a STEM detector at 28 kV.

#### 2.17. Controls

We controlled for the effects of cryoprotectant introduction and vitrification by preparing rabbit brains using the same surgical



**Fig. 5.** Cells of the CA1 band of rabbit hippocampus. KR8H washout solution. Vitrified; CPA removed by perfusion. Experiment date: 2015-04-21. 2,420 $\times$ .

procedures, perfusion machines, and chemicals as with ASC preserved brains, except that after 45 min total fixative perfusion we did not begin the CPA gradient. Instead we transferred the rabbit cephalon to a refrigerator at 4 °C for at least 4 h, then removed the brain from the skull and performed staining, dehydration, embedding, and analysis as described above.

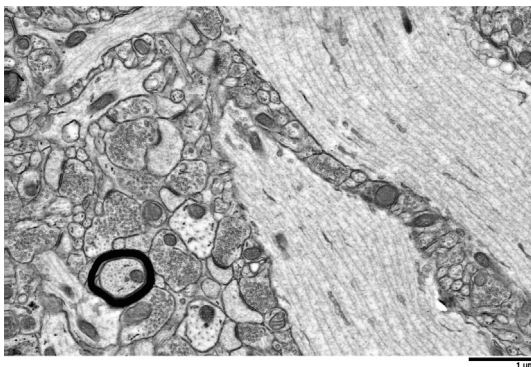
### 3. Results

#### 3.1. Preservation of rabbit brains

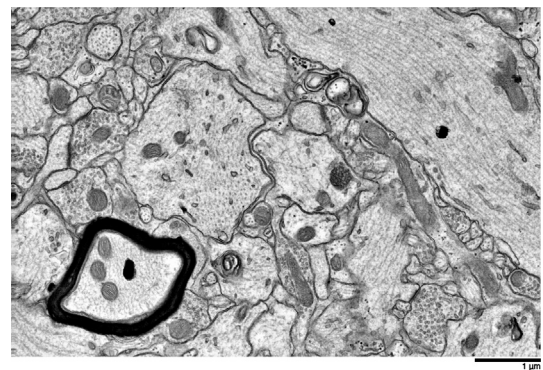
Of the 37 rabbits used during the course of these experiments, 29 were used to refine the parameters of the ASC protocol and establish controls and 8 were processed using the ASC protocol

described previously. Of these 8 rabbits processed for ASC, 3 were processed with KR8H washout solution, 3 were processed with PBS washout solution, and 2 were processed with PBS washout solution with 10 g/L sodium nitrite included.

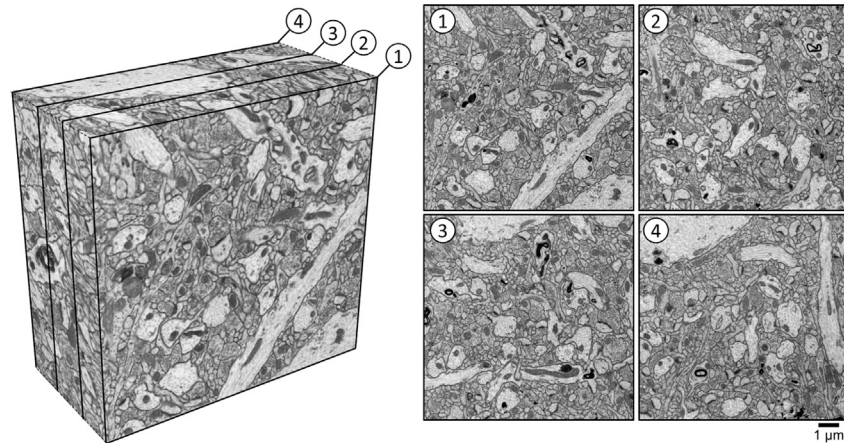
Gross observation of all 8 ASC processed rabbit brains upon dissection revealed no cracks resulting from the vitrification or rewarming processes. Brain weights were commensurate with control brains, and we found no retraction of the brains from their skulls. Control rabbit brains displayed excellent ultrastructural preservation, as expected. Fig. 4 shows control CA1 hippocampal neurons at relatively low magnification (2,420 $\times$ ). All 8 rabbit brains preserved using ASC consistently displayed ultrastructural preservation indistinguishable from that of controls, as indicated



**Fig. 6.** Rabbit brain. Neuropil near the CA1 band in the hippocampus. Control: Brains were washed out with PBS washout solution, fixed for 45 min, then stained and embedded. Experiment date: 2015-05-27. 15,500 $\times$ .



**Fig. 7.** Rabbit brain. Neuropil near the CA1 band in the hippocampus. Synapses, vesicles, and microfilaments are clear. The myelinated axon shows excellent preservation. KR8H washout solution. Vitrified; CPA removed by diffusion. Experiment date: 2015-04-15. 15,500 $\times$ .



**Fig. 8.** Frames from a FIB-SEM stack of rabbit neuropil near the CA1 band of the hippocampus. Stack dimensions:  $10\ \mu\text{m} \times 10\ \mu\text{m} \times 5\ \mu\text{m}$ . All processes appear well preserved and traceable throughout the stack. Full video available in supplemental materials. KR8H washout solution. Vitriified; CPA removed by diffusion. Experiment date: 2015-04-15. FIB-SEM done by Ken Hayworth at Janelia Research Campus. Used with permission.

in Fig. 5 showing ASC-preserved pyramidal neurons also from the CA1 band of the rabbit hippocampus at the same magnification. In both electron micrographs, uniformly intact cell membranes are clearly visible and cells appear clear. The absence of “dark” neurons [2], indicates proper fixation and the lack of mechanical disruption to brain tissue. Nuclear envelopes are clearly defined and display no discontinuities. Intracellular organelles are also well preserved: rough endoplasmic reticulum is clear and compact, and the mitochondria appear normal, with cristae clearly visible even at the relatively low magnification of the image. There are no visible examples of exploded and vacuolated (or “popcorned” [27]) mitochondria. The few darkly-stained myelinated transverse processes seen are well-preserved, with tight myelin sheaths.

Fig. 6 is a high magnification ( $15,500\times$ ) shot of neuropil near the CA1 band of a control rabbit hippocampus, and Fig. 7 shows a comparable area in an ASC-preserved brain. Both images show a single myelinated axon and several other unmyelinated synaptic processes. Each process is unambiguously defined by crisp membranes. There are several synapses present, with clear pre-synaptic vesicles and well defined, darkly stained post-synaptic densities. At this level of magnification, the cristae of the mitochondria are readily apparent. The large process in the upper right of the image displays clear neurofilaments and a clear cytoskeleton; a transverse

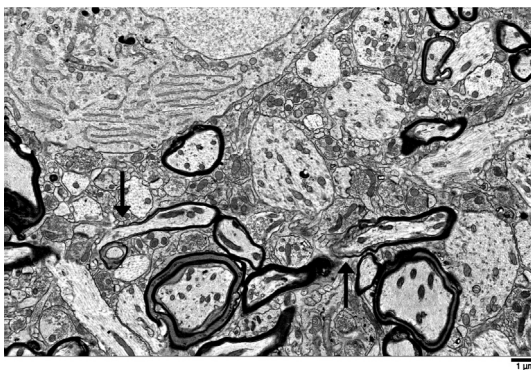
view of the cytoskeleton can be seen in the neural process in the center of the image.

Perfusion removal of CPA resulted in ultrastructural preservation equivalent to diffusion removal of CPA: The brain shown in Fig. 7 had CPA removed via perfusion while the brain shown in Fig. 5 had CPA removed via diffusion. There is no appreciable difference between the quality of preservation attained in these two cases, or in other similar comparisons not shown.

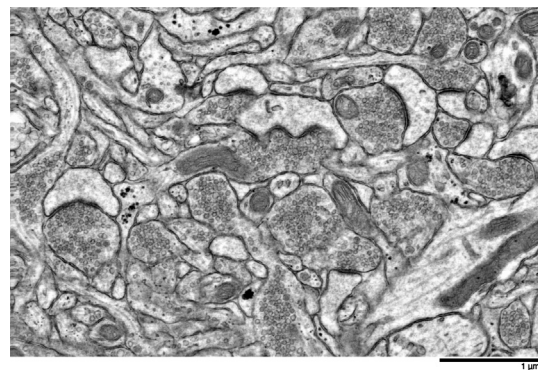
To demonstrate the suitability of ASC brains for connectome tracing studies, Ken Hayworth at the Janelia Research Campus in Virginia kindly agreed to carry out FIB-SEM imaging of a  $10\ \mu\text{m} \times 10\ \mu\text{m} \times 5\ \mu\text{m}$  region of rabbit hippocampus that had been preserved using ASC. Fig. 8 shows several slices from that volume. Overall structural preservation is excellent: processes are clearly defined and organelles are intact, as expected. When observing slices of this volume in sequence, it is easy to track the progression of any process through the stack, demonstrating that connectivity in this region was not impaired by our preservation method (see full video available in online supplemental materials).

Supplementary data related to this article can be found online at <http://dx.doi.org/10.1016/j.cryobiol.2015.09.003>.

Figs. 9 and 10 further demonstrate the level of preservation that can be obtained using ASC. Fig. 9 shows the edge of a CA1 pyramidal cell from the rabbit hippocampus. Nuclear pores and a Golgi

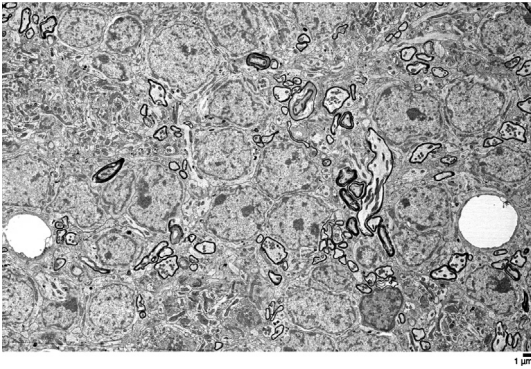


**Fig. 9.** Excellent preservation of myelinated and unmyelinated axons near a CA1 cell in rabbit hippocampus. Cell organelles and endoplasmic reticulum appear normal. Note the nodes of Ranvier (arrows) in the middle of the image. PBS washout solution. Vitriified; CPA removed by diffusion. Experiment date: 2015-04-22.  $5,450\times$ .



**Fig. 10.** Neuropil near CA1 band of rabbit hippocampus. High magnification image of multiple synapses showing clear pre-synaptic vesicles and post-synaptic densities. PBS washout solution with  $10\ \text{g/L}$  sodium nitrite. Vitriified; CPA removed by diffusion. Experiment date: 2015-05-06.  $23,130\times$ .





**Fig. 11.** Rabbit cerebellum. Overall structure appears good; myelinated and unmyelinated processes are clear. PBS washout solution with 10 g/L sodium nitrite. Vitrified; CPA removed by diffusion. Experiment date: 2015-05-06. 2,180 $\times$ .

apparatus are visible. Two nodes of Ranvier are also visible near the center of the image. Fig. 10 shows detailed, classic “clasping hand” synapses, as well as one synapse with three post-synaptic densities. Pre-synaptic neurotransmitter vesicles are clearly defined.

We also investigated preservation in the cerebellum and thalamus and found acceptable preservation in both cases. Fig. 11 shows ASC preserved rabbit cerebellum. All cells appear well preserved, and the two capillaries shown display good integrity, are not collapsed, and are free of debris. There is some slight loosening of the myelin sheath surrounding one of the heavily myelinated processes, but the process itself is still well defined, which would enable uninterrupted connectomic analysis.

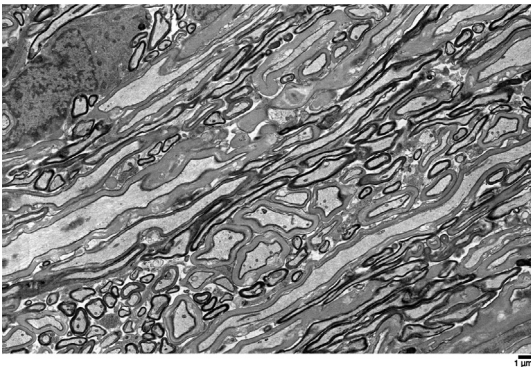
Fig. 12 shows preservation in rabbit thalamus. Here there is some apparent damage to the myelin sheaths of the heavily myelinated tracts of axons. However, even in the presence of this damage, all processes appear to us to be traceable and intact, and thus suitable for connectomic analysis.

In general, the ultrastructure in each of these figures displays the lack of extracellular space which is typical of perfuse-fixed brain tissue prepared for electron microscopy [6,19].

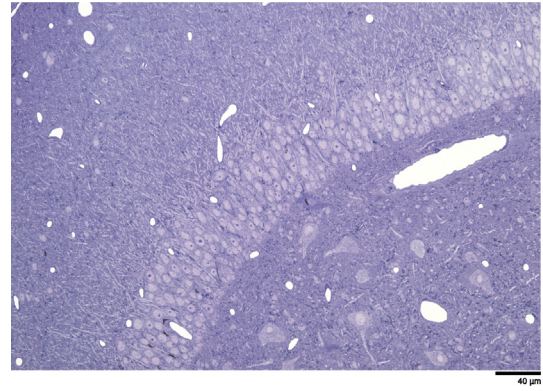
### 3.2. Preservation of pig brains

Of the three pigs used during the course of these experiments, surgical complications led to two pigs suffering ischemic time in excess of 15 min (micrographs not shown). The remaining pig was successfully processed using ASC as described previously.

Fig. 13 shows a histology image of pig hippocampal CA1



**Fig. 12.** Rabbit thalamus. There is some distortion of the heavily myelinated axons, though all processes appear traceable. PBS washout solution with 10 g/L sodium nitrite. Vitrified; CPA removed by diffusion. Experiment date: 2015-05-06. 3,310 $\times$ .



**Fig. 13.** Pig hippocampus CA1 band and cortex. Note the excellent histology of all cells present. 0.33 µm section stained with toluidine blue. PBS washout solution. Vitrified; CPA removed by diffusion. Experiment date: 2015-04-28. 20 $\times$ .

pyramidal neurons and surrounding cortex. This entire region of brain tissue displays excellent preservation: All capillaries are open and clear of debris, there are no “dark” cells, and there is no obvious mechanical or osmotic disruption or distortion of any cells.

Fig. 14 is an image of pig neuropil near the CA1 hippocampal band and is comparable to the rabbit micrographs shown in Figs. 8 and 9. As in those images, there are multiple well-preserved synapses, mitochondria appear normal, neurofilaments appear undamaged, and all processes are clearly defined by well-preserved membranes.

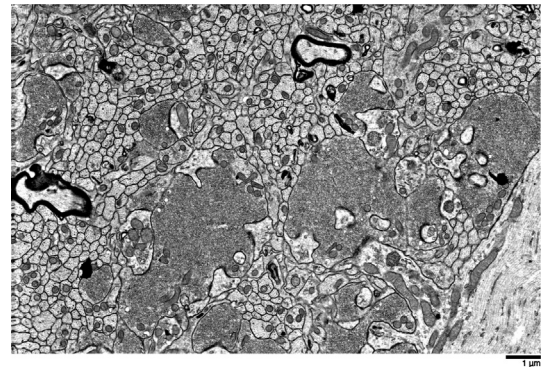
In general, there was no difference in the quality of preservation obtained using pig or rabbit brains. Additional pig brain images as well as a FIB-SEM video are available in the online supplemental materials.

### 3.3. General methodological observations

We did not see any difference in preservation quality between KR8H blood washout solution (Table 3) (shown in Figs. 5, 7 and 8) and the simpler PBS-based blood washout solution (Table 2) (shown in Figs. 4–6 and 8–10 and 13 and 14).

For some experiments such as those shown in Figs. 11 and 12, we employed 10 g/L sodium nitrite in the washout solution as a vasodilator [28]. We found no difference in the quality of preservation obtained with or without sodium nitrite.

On the other hand, we found that 0.1% w/v sodium azide added to our initial fixative solution completely eliminated “popcorn



**Fig. 14.** Neuropil of pig brain near the CA1 area of the hippocampus. Note the large “pools” of vesicles. PBS washout solution. Vitrified; CPA removed by diffusion. Experiment date: 2015-04-28. 8,050 $\times$ .

mitochondria” in our electron micrographs, which we often observed without the azide. Sodium azide has been used previously to prevent mitochondrial swelling during immersion fixation [27].

## 4. Discussion

### 4.1. Brain cryoprotection, dehydration prevention, and vitrification

We chose ethylene glycol as the sole cryoprotectant in our CPA solution (Table 6) based in part on permeability studies we conducted on fixed brain slabs which indicated that ethylene glycol was the most permeable of all CPAs studied. It would be reasonable to assume that fixation would permeabilize both the blood–brain barrier and the brain itself to cryoprotectants, but we rapidly learned that this was far from the case: we observed gross brain shrinkage and shrunken and dehydrated myelin processes, even with very extended (80 h) cryoprotectant introductions and very low (50 mOsm) phosphate buffer osmolalities (images not shown) even using the most permeable CPA available. We therefore employed SDS in view of the fact that SDS can be used to reversibly permeabilize the blood–brain barrier in rats [32], and has previously been used to accelerate cryoprotectant uptake in unfixed tissue (Yuri Pichugin, personal communication). SDS was found to be critical for our purposes by allowing cryoprotectant to penetrate the brain without causing shrinkage. When SDS was included, we found no observable brain shrinkage when measuring brain weight or examining ultrastructure.

We are confident that both small and large ASC brains processed as described vitrify when cooled. 65% w/v ethylene glycol is 10% w/v more concentrated than a concentration that will vitrify at a cooling rate of about 10 °C/min [12], and should have an extremely low critical cooling rate. Most of our brains approached –140 °C prior to rewarming, and all descended to at least –135 °C, whereas the glass transition temperature of 65% w/v ethylene glycol even when a carrier is absent is close to –131 °C [16]. We also observed no signs of ice crystal artifacts in any of our ASC-processed brains.

To further demonstrate vitrification of our cryoprotectant solution, we prepared a sample of our cryoprotectant solution and stored it in the CIVS for 12 h, monitoring temperature with the same needle thermocouple we used for the rabbit cephalons. After removing the sample of cryoprotectant after it had reached –135 °C, we found that it had formed a solid glass, without crystals.

Vitrified storage at –135 °C should enable essentially indefinite storage of brain tissue with no degradation due to suppressed molecular motion in the vitrified state.

### 4.2. Brain banking for the 21st century

Aldehyde-stabilized cryopreservation promises to be a superior brain banking technique compared to other methods. ASC can enable preservation of precious samples such as brains from expensive or extensively modified research animals. These samples can then be analyzed by multiple labs and by multiple techniques that are compatible with previous aldehyde fixation, without constraints on sample storage time. Current fixation methods do not allow indefinite preservation [20,37], a problem that ASC is believed to solve, given that the standard principles of cryopreservation [15,16] apply to ASC-preserved brains. Thus, we believe the current studies show that the principles and methods of cryobiology in general and of organ vitrification in particular have now been demonstrated to have applications in a new area of biological research.

We studied the hippocampus in part because it is a brain region

that is particularly sensitive to ischemic injury [31] and thus in principle a particularly delicate and challenging structure to preserve. It is also essential for the formation of long-term memories [35], and CA1 cells in particular pass information from the hippocampus to other sites in the brain [1]. Therefore, the results obtained for CA1 cells in the present work are particularly encouraging for demonstrating the ability of ASC to preserve both delicate and complex brain structures.

We have shown that cryoprotectant can be removed either by simple diffusion (Fig. 7) or by reperfusion for gradual removal (Fig. 5). Perfusion removal of CPA enables a smooth transition to any technique that can start with an aldehyde-fixed brain (even ones that require subsequent perfusion with different chemicals), and is appropriate when CPA must be removed from the whole brain prior to analysis.

We envision that ASC brains might be subsequently embedded using a whole brain staining and embedding protocol such as Mikula’s BROPA protocol [26], or used with completely different whole brain perfusion based protocols such as the CLARITY method [4], expansion microscopy [3], or other methods yet to be devised. Preserved brain slices can also be taken and shipped to multiple labs for analysis. Collaborative research of this kind should extend access to complex analytic techniques, enabling a single lab with access to unique material to stockpile brains and then distribute them to multiple analytical sites, and even to sites that did not exist at the time of stockpiling.

We have shown that both rabbit brains (10 g) and pig brains (80 g) can be preserved equally well. We do not anticipate that there will be significant barriers to preserving even larger brains such as bovine, canine, or primate brains using ASC. We do not, however, necessarily see easy application of our method in current human brain banks [23], because these banks normally receive donated brains many hours after death, which we assume will make them difficult to adequately perfuse. Furthermore, we do not see any simple way for ASC to be compatible with research protocols which require both fixed and unfixed tissue from the same brain; ASC delivers chemicals via perfusion and so must fix and cryopreserve the entire brain.

Although we have emphasized the neurobiological applications of ASC here, our method is general and should be applicable to any organ system, or even to entire animals. The National Institute on Aging, for example, maintains stocks of aged animals – a transient and precious resource – and samples might be preserved for later analysis by gerontologists. In another instance, human organs provided to scientists by organizations such as the National Disease Research Interchange might also be processed using ASC to ensure that organs suitable for morphological studies are always available and not needlessly wasted. Finally, although we have used glutaraldehyde for preserving ultrastructure, other fixatives can also be used with ASC to enable, for example, better detection of epitopes that might be altered by glutaraldehyde.

In the present work, we’ve shown the development of a new and general brain banking technique for connectomics and other types of neuroanatomical research that should enable valuable material to be preserved without time constraints and shared between labs for comprehensive examination. ASC promises to be a powerful new technique in the quest of connectomics researchers to unravel the mysteries of the mind. We also hope that ASC will inspire investigators in other fields to consider the possibility of cryobiological solutions to their problems.

### Conflicts of interest

None.

## Acknowledgments

This research was supported by 21st Century Medicine and by the Brain Preservation Foundation.

We thank Brian Wowk for providing perfusion engineering and thermodynamics advice, programming the LabView computer pressure control interfaces, and help with editing of the manuscript. We further thank Dylan Holmes for creating the perfusion machine diagrams and extensive editing help, Bruce Thomson for his excellent electron microscope work and support, and Ken Hayworth for generously providing FIB-SEM analysis of our brain samples. Annemarie Southern and Anita Williams prepared many of our solutions, and Victor Vargas performed the analytical chemistry work for our brain slab permeability studies and spectroscopic studies of the purity of our glutaraldehyde solutions. Victor Vargas and Limdo Chow also helped construct the pig perfusion machine. Last but not least, we are indebted to Xian Ge, Roberto Pagotan, Adnan Sharif, and Angie Olivia for providing necessary animal surgical support and to John Phan for advice on cryoprotectant perfusion techniques.

## References

- [1] P. Andersen, R. Morris, D. Amaral, T. Bliss, J. O'Keefe, *The Hippocampus Book*, Oxford University Press, 2007.
- [2] J. Cammermeyer, The importance of avoiding "dark" neurons in experimental neuropathology, *Acta Neuropathol.* 1 (1961) 245–270.
- [3] F. Chen, P.W. Tillberg, E.S. Boyden, Expansion microscopy, *Science* 347 (2015) 543–548. <http://expansionmicroscopy.org/15.01.chen.FULL.pdf>.
- [4] K. Chung, J. Wallace, S.-Y. Kim, S. Kalyanasundaram, A.S. Andalman, T.J. Davidson, J.J. Mirzabekov, K.A. Zalocusky, J. Mattis, A.K. Denisin, S. Pak, H. Bernstein, C. Ramakrishnan, L. Grosenick, V. Gradinaru, K. Deisseroth, Structural and molecular interrogation of intact biological systems, *Nature* 497 (2013) 332–337. <http://www.nature.com/nature/journal/v497/n7449/full/nature12107.html>.
- [5] P. Clark, G. Fahy, J.A.M. Karrow, Factors influencing renal cryopreservation. ii. toxic effects of three cryoprotectants in combination with three vehicle solutions in nonfrozen rabbit cortical slices, *Cryobiology* 21 (1984) 274–284.
- [6] B. Cragg, Preservation of extracellular space during fixation of the brain for electron microscopy, *Tissue Cell* 12 (1980) 63–72.
- [7] M. Eisenstein, Neural circuits: Putting neurons on the map, *Nature* 461 (2009) 1149–1152. <http://www.nature.com/nature/journal/v461/n7267/full/4611149a.html>.
- [8] G. Fahy, D. MacFarland, C. Angell, H. Meryman, Vitrification as an approach to cryopreservation, *Cryobiology* 21 (1984) 407–426.
- [9] G. Fahy, W. Rall, Vitrification: an overview, in: J. Liebermann, M.J. Tucker (Eds.), *Vitrification in Assisted Reproduction: a User's Manual and Troubleshooting Guide*, Informa, UK, 2007, pp. 1–20.
- [10] G. Fahy, T. Takahashi, A. Crane, Histological cryoprotection of rat and rabbit brains, *CryoLetters* 5 (1984) 33–46.
- [11] G.M. Fahy, Activation of alpha adrenergic vasoconstrictor response in kidneys stored at  $-30^{\circ}\text{C}$  for up to 8 days, *CryoLetters* 1 (1980) 312–317.
- [12] G.M. Fahy, Vitrification, in: J. McGrath, K. Diller (Eds.), *Low Temperature Biotechnology: Emerging Applications and Engineering Contributions*, The American Society of Mechanical Engineers, New York, 1988, pp. 113–146.
- [13] G.M. Fahy, Organ perfusion equipment for the introduction and removal of cryoprotectants, *Biomed. Instrum. Technol.* 28 (1994) 87–100.
- [14] G.M. Fahy, Cryoprotectant toxicity neutralization, *Cryobiology* 60 (2010) S45–S53. <http://www.21cpublications.com/PubFiles/12/2010Fahytoxneutral.pdf>.
- [15] G.M. Fahy, W.F. Rall, Overview of biological vitrification, in: M.J. Tucker, J. Liebermann (Eds.), *Vitrification in Assisted Reproduction: from Basic Science to Clinical Application*, Taylor & Francis Books, Ltd., New York, 2015.
- [16] G.M. Fahy, B. Wowk, Principles of cryopreservation by vitrification, *Methods Molec. Biol.* 1257 (2015) 21–82.
- [17] G.M. Fahy, B. Wowk, J. Wu, J. Phan, C. Rasch, A. Chang, E. Zendejas, Cryopreservation of organs by vitrification: perspectives and recent advances, *Cryobiology* 48 (2004) 157–178.
- [18] G. Griffiths, *Fine Structure Immunocytochemistry*, Springer-Verlag, 1993.
- [19] M. Hayat, *Fixation for Electron Microscopy*, Academic Press, 1991.
- [20] M. Hooshmand, A. Anderson, B. Cummings, Improved pre-embedded immuno-electron microscopy procedures to preserve myelin integrity in mammalian central nervous tissue, in: Méndez-Vilas (Ed.), *Microscopy: Advances in Scientific Research and Education*, Formatex Research Center, 2014, pp. 59–65.
- [21] H. Kalimo, L.J. Pelliniemi, Pitfalls in the preparation of buffers for electron microscopy, *Histochem. J.* 9 (1977) 241–246.
- [22] G. Knott, S. Rosset, M. Cantoni, Focused ion beam milling and scanning electron microscopy of brain tissue, *J. Vis. Exp.* e2588. URL <https://www.jove.com/video/2588/focused-ion-beam-milling-scanning-electron-microscopy-brain>.
- [23] H. Kretschmar, Brain banking: opportunities, challenges and meaning for the future, *Nat. Rev. Neurosci.* 10 (2009) 70–78. <http://www.nature.com/nrn/journal/v10/n1/full/nrn2535.html>.
- [24] J.W. Lichtman, J.R. Sanes, J. Livet, A technicolour approach to the connectome, *Nat. Rev. Neurosci.* 9 (6) (2008) 417–422. <http://www.ncbi.nlm.nih.gov/pubmed/18446160>.
- [25] S. Mikula, J. Binding, W. Denk, Staining and embedding the whole mouse brain for electron microscopy, *Nat. Methods* 9 (2012) 1198–1201. <http://www.nature.com/nmeth/journal/v9/n12/abs/nmeth.2213.html>.
- [26] S. Mikula, W. Denk, High-resolution whole-brain staining for electron microscopic circuit reconstruction, *Nat. Methods* 12 (2015) 541–546. <http://www.nature.com/nmeth/journal/v12/n6/full/nmeth.3361.html>.
- [27] H. Minassian, S.-N. Huang, Effect of sodium azide on the ultrastructural preservation of tissues, *J. Microsc.* 117 (1979) 243–253.
- [28] S.L. Palay, S.S. Gordon, M. McGee-Russell, M.A. Grillo, Fixation of neural tissues for electron microscopy by perfusion with solutions of osmium tetroxide, *J. Cell Biol.* 12 (1962) 385–410. <http://jcb.rupress.org/content/12/2/385.full.pdf>.
- [29] E.A. Robertson, R.L. Schultz, The impurities in commercial glutaraldehyde and their effect on the fixation of brain, *J. Ultrastruct. Res.* 30 (1970) 275–287.
- [30] D.L. Rosene, K.J. Rhodes, Cryoprotection and freezing methods to control ice crystal artifact in frozen sections of fixed and unfixed brain tissue, *Methods Neurosci.* 3 (1990) 360–385.
- [31] Y.-W. Ruan, Z. Lei, Y. Fan, B. Zou, Z.C. Xu, Diversity and fluctuation of spine morphology in ca1 pyramidal neurons after transient global ischemia, *J. Neurosci. Res.* 87 (2009) 61–68.
- [32] A. Saija, P. Princi, D.T.M. Lanza, A.D. Pasquale, Changes in the permeability of the blood-brain barrier following sodium dodecyl sulphate administration in the rat, *Exp. Brain Res.* 115 (1997) 546–551.
- [33] S. Seung, *Connectome: How the Brain's Wiring Makes Us Who We Are*, Houghton Mifflin Harcourt Publishing, 2012.
- [34] O. Sporns, Contributions and challenges for network models in cognitive neuroscience, *Nat. Neurosci.* 17 (2014) 652–660. <http://www.nature.com/neuro/journal/v17/n5/full/nn.3690.html>.
- [35] J.Z. Tsien, P.T. Huerta, S. Tonegawa, The essential role of hippocampal ca1 nmda receptor-dependent synaptic plasticity in spatial memory, *Cell* 87 (1996) 1327–1338.
- [36] B. Wowk, Thermodynamic aspects of vitrification, *Cryobiology* 60 (2010) 11–22.
- [37] R. Xie, J.-Y. Chung, K. Ylaja, R.L. Williams, N. Guerrero, N. Nakatsuka, C. Badie, S.M. Hewitt, Factors influencing the degradation of archival formalin-fixed paraffin-embedded tissue sections, *J. Histochem. Cytochem.* 59 (4) (2011) 356–365.